

INSTALLATION NOTES

PROFESSIONAL INSTALLATION IS STRONGLY RECOMMENDED!

If you intend to do this installation yourself, please use extreme caution when working under a vehicle that is supported with jack stands. Serious injury or death can occur.

Read through entire installation manual to ensure that you understand all of the steps before proceeding with installation. If these instructions are not properly followed, severe frame, suspension, and tire damage may occur. Product failure or vehicle damage caused by improper installation will not be covered under warranty!

Remove all contents from the package and inspect for any damage. Also, verify that all components listed are included before you begin installation. If anything is missing or damaged please contact us at customerservice@cyc-engineering.com - IMPORTANT: DO NOT INSTALL DAMAGED PARTS!

COMPONENTS

Qty: 2 Rear Upper Link Arms



TOOLS REQUIRED



Jack Stands



8mm Allen Wrench

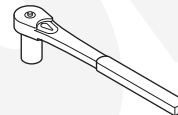

17mm Socket

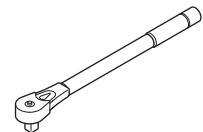

Torque Wrench



Jack

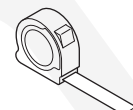

Tape Measure

ADJUSTABLE REAR UPPER LINK ARMS

SKU# 150308-435900

RSO SUSPENSION

1. Using a correct weight rated jack, raise the rear of the vehicle and place jack stands on the vehicles jack points. Chock the front tires to ensure no movement while working under your vehicle. Once the back of the vehicle is off the ground and secured, remove the rear wheels.

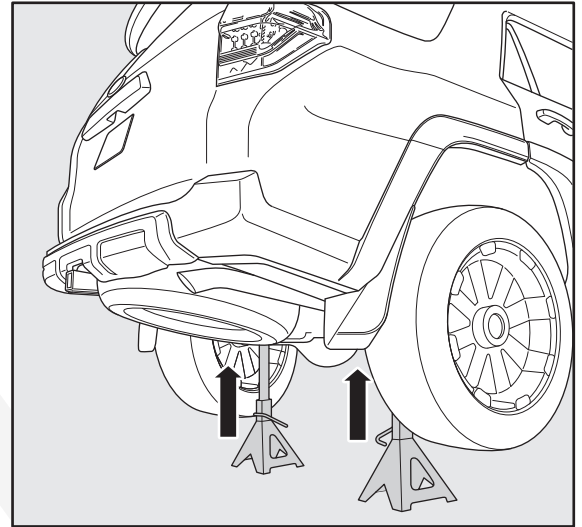

2. Using a hydraulic jack raise the rear axle to relieve tension on the rear arms to make removal easier.

3. Use a 17mm socket to remove the factory bolts holding the rear upper link arm to the frame and axle mounts. Retain the factory hardware as it will be reused for installation of the new RSO Adjustable Rear Upper Link Arms.

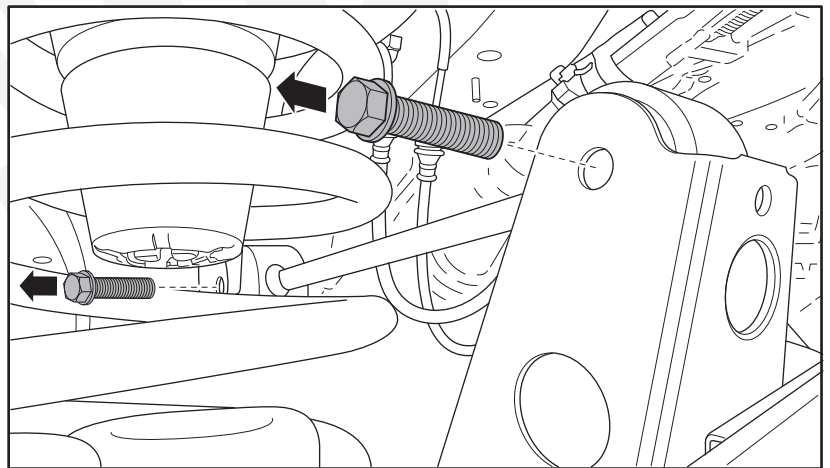

4. Use an 8mm allen wrench to loosen the pinch bolts on the RSO link arm and adjust the rod end and adjustment collar so the RSO link arm matches the length of the factory rear upper link arm. This will work as your base starting length and make final adjustments quicker. Once adjusted to the same length hand tighten the pinch bolts but do not torque down.

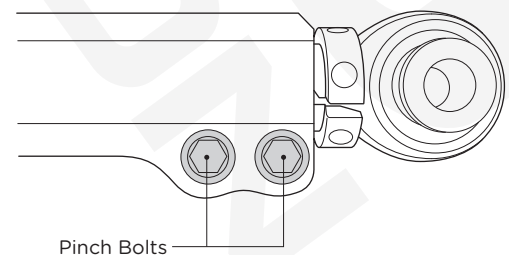

ADJUSTABLE REAR UPPER LINK ARMS

SKU# 150308-435900

RSO
SUSPENSION

- 5.** Mount the included misalignment spacers into the rod end and install into the axle side mount, secure the link arm using the factory hardware. Do not torque down until all adjustments are finalized. Insert the bushing into the frame side link arm mount and secure using the factory hardware. Do not torque down until all adjustments are finalized.

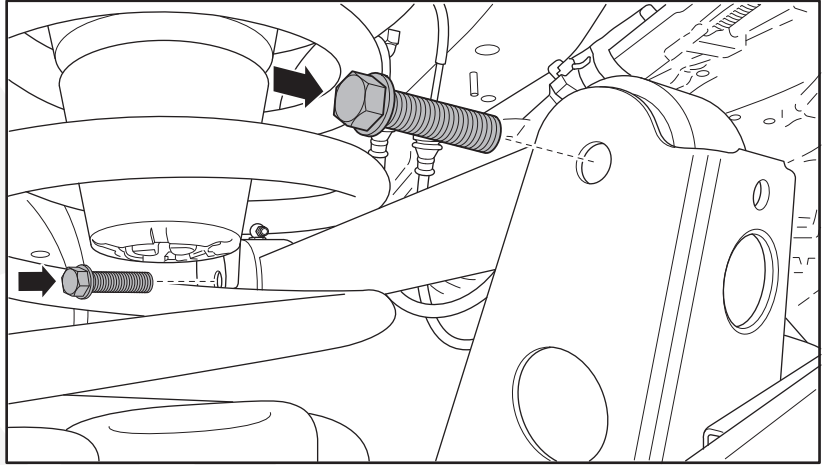

- 6.** Repeat the steps for the opposite side and leave all hardware hand tight. Lower the vehicle to the ground until the coil springs are supporting the full weight of the vehicle. Measure both side of the vehicle to ensure the axle position matches. Measure the pinion angle to ensure it is within factory specs, you can adjust the length of the link arm to get more or less pinion angle as well as centering the axle in the wheel well. To ensure the adjustment collar and rod end do not rotate, ensure the cut in the collar lines up with the cut on the billet link arm. Once you have determined pinion angle and axle position are within spec, use a torque wrench to tighten the pinch bolts to 35ft/lbs and the factory mounting bolts to 59ft/lbs. If your vehicle is equipped with KDSS, reference the factory owner's manual for reactivation steps.

- 7.** We now recommend a professional alignment. Check all hardware after 100 miles of driving and retorqued as necessary.

REGULAR MAINTENANCE SCHEDULE

Link Arms are essentially maintenance free, however the bushings and rod ends are consumable components. See Signs of Wear below for more information.

For the rod ends, a visual inspection at every oil change is recommended to detect any accumulation of dirt or debris.

CLEANING & LUBRICATION

Should dirt accumulate on the rod ends, flush out components with WD40 and reapply a dry lubricant containing Teflon (PTFE).

SIGNS OF WEAR

Excessive back and forth play or rattling in the bushings indicates wear. In such instances, it is imperative to replace the affected parts promptly.

Excessive back and forth play in the rod ends indicates wear. In such instances, it is imperative to replace the affected parts promptly

You can order replacement parts at www.cyc-engineering.com

Replacement Part numbers for this particular SKU are listed below for your reference.

SKU: REP-BUSHING-14-KIT (Replacement Rubber Bushings)

SKU: REP-JM12T-KIT (Replacement Rod Ends)

TECHNICAL NOTES

It is crucial not to exceed 2 inches of adjustment from the center of the rod end to the edge of the upper link arm. Failure to adhere to this limitation may void warranty coverage.