

GTS10FD

# MAGNUM RT GEN 2 STEPS

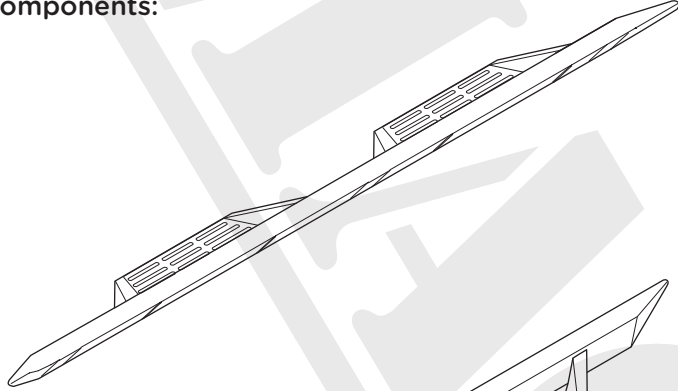

## Components:



Passenger Side Step Bar Qty 1

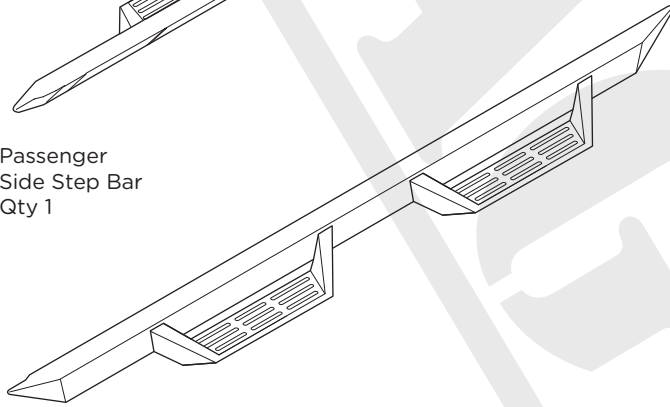

Driver Side Step Bar Qty 1

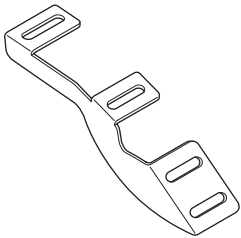

Driver & Passenger Front Bracket Qty 2

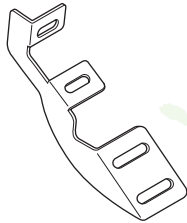

Driver & Passenger Center and Rear Bracket Qty 4

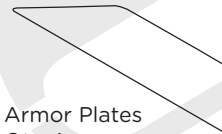

Armor Plates Qty 4

## Hardware:



M8 x 25 mm Hex Head Bolts Qty 18



M8 Hex Head Nuts Qty 6



M8 Flat Washers Qty 24



M8 Lock Washers Qty 24

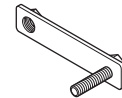

RTSPN175 Bolt/Nut Plates Qty 6



M8 Plastic Push Nuts Qty 6

## Tools Required:

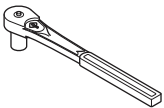

RATCHET

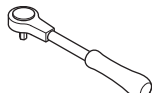

TORQUE WRENCH



13MM SOCKET

## Torque Specifications:

For Rocker Panel Mount Installations  
M8 through M12 bolts and nuts are set to 15-20 ft lbs.

**Note: When installing the brackets and bars, all hardware must be left loose until all the items are attached.**

**1.** Remove all contents from the package and check stainless steel tubes for any damage. Also, verify that all components and hardware listed above are included before you begin installation.

**2.** Read installation manual and installation drawing completely. Understand all brackets and bolts before installation.

**3.** Begin installation on the drivers's side. Front and Center Bracket Cradle face to the rear of truck and Rear Bracket Cradle faces to front of truck.

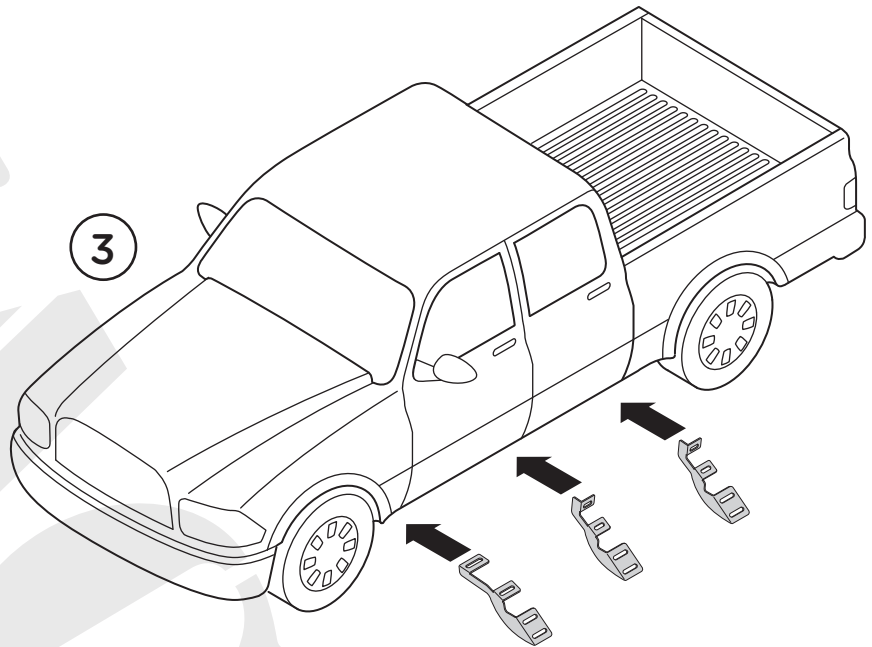

**4.** Fasten each bracket using two (2) M10 x 30MM Hex Head Bolts, two (2) M10 Flat Washers, two (2) M10 Lock Washers.

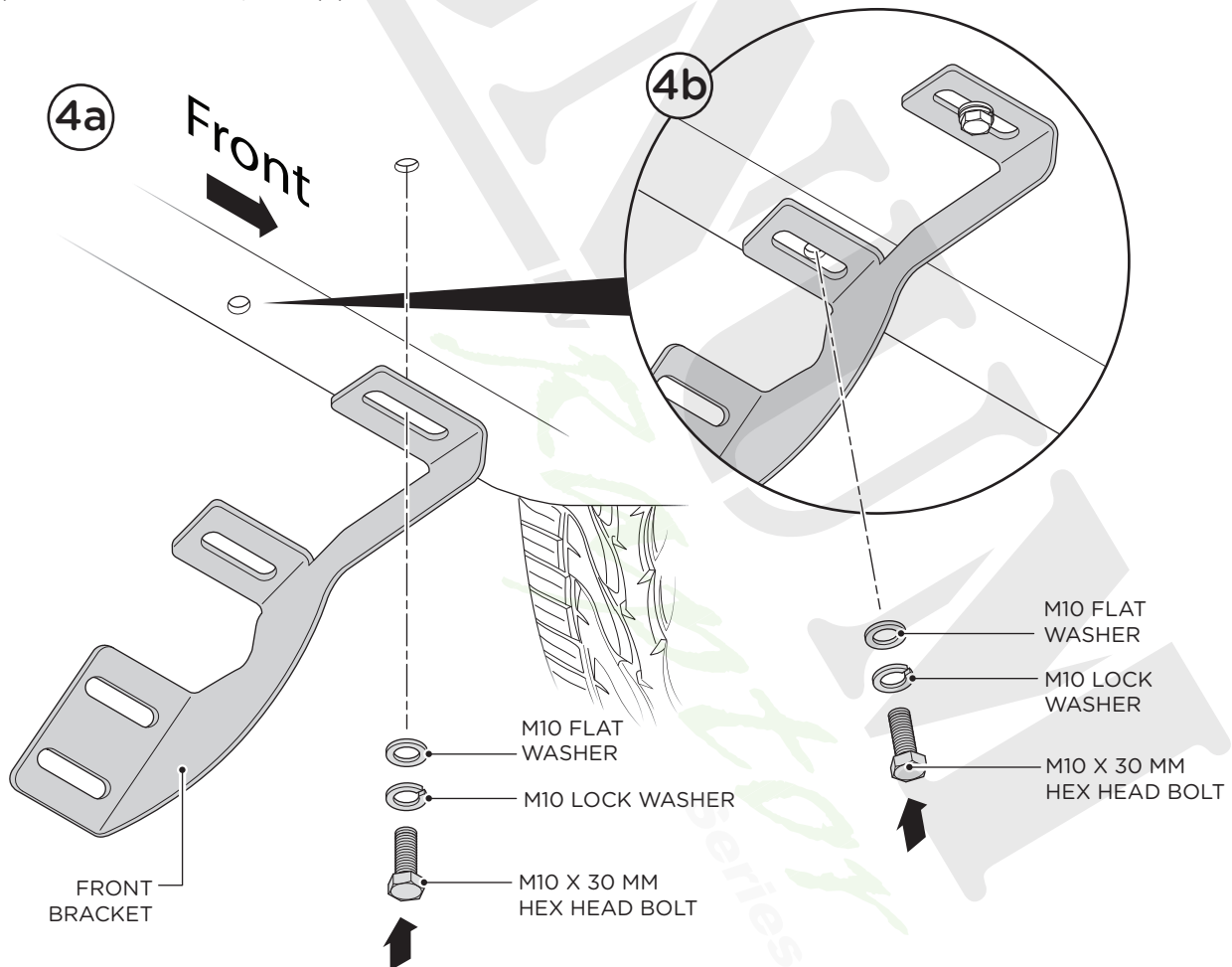

5. Fasten each bracket using two (2) M10 x 30MM Hex Head Bolts, two (2) M10 Flat Washers, two (2) M10 Lock Washers.

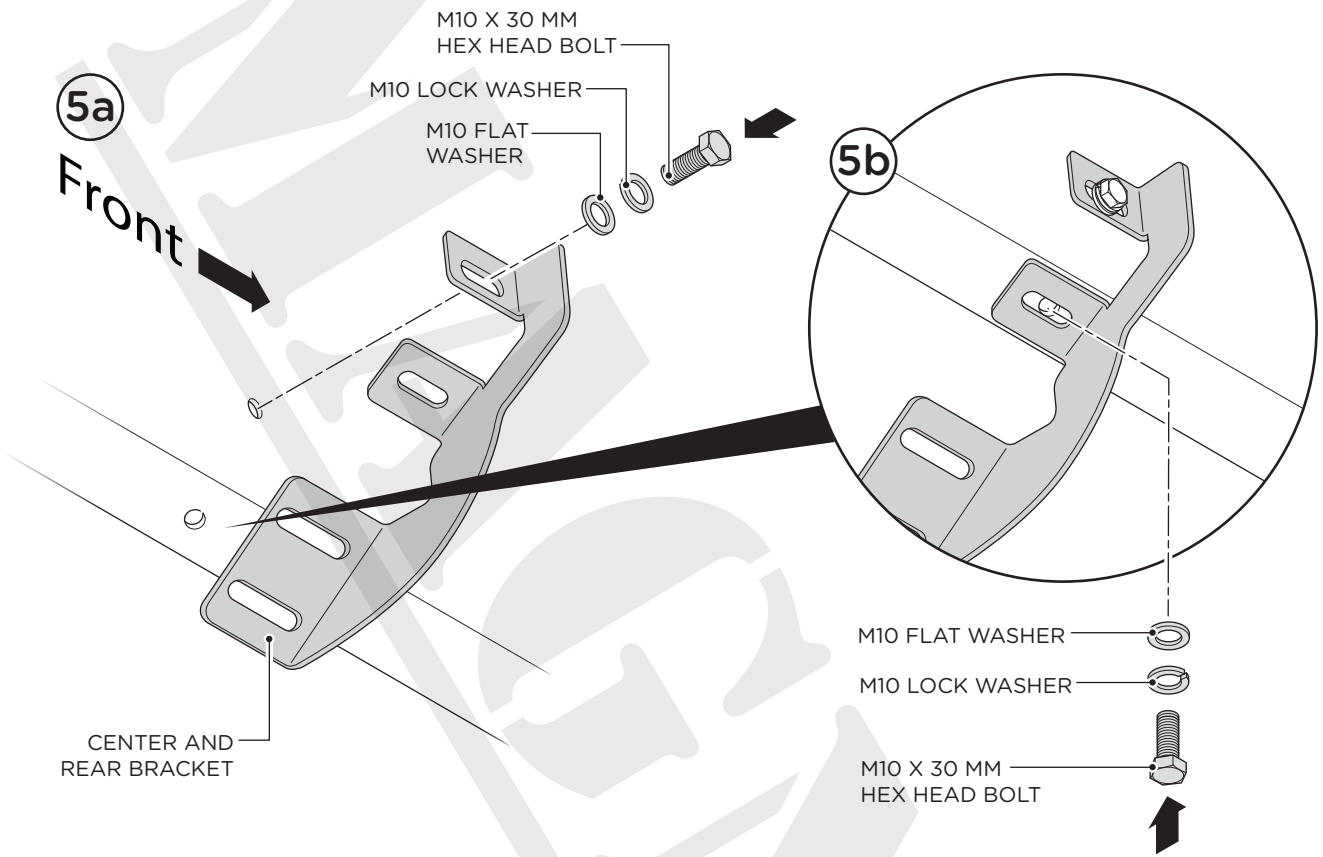

## Installing the Step Bar

**6.** Line up mounting points on the step bar with the mounting holes in each bracket.

**7.** Fasten the step bar to each bracket using one (1) RTSPN175 Bolt/Nut Plate, one (1) Plastic Push Nut, one (1) M8 Hex Head Nut, two (2) M8 Lock Washers, two (2) M8 Flat Washers and one (1) M8 x 25MM Hex Head Bolt.

**8.** Adjust the bars front/back and up/down to desired placement. Once you have the step positioned, tighten until the split lock washer is flat between the bolt head and flat washer. Do not over tighten.

**9.** When all hardware is in place, everything must be tightened. See page 1 for torque specifications. Repeat these steps for opposite side installation.

### OPTIONAL:

If you wish to install the Front Armor Plates, begin by thoroughly cleaning the front side of the front step where the Front Armor Plate will attach.

**1.** Remove adhesive protection from the Front Armor Plate.

**2.** Carefully line up with the front side of the front step. Be careful not to let the side overhang as they could peel off over time.

Once lined up, firmly press the Front Armor Plate on the step to ensure complete adhesion.

Repeat these steps for opposite side.

