

GTS71JP

MAGNUM RT STEPS

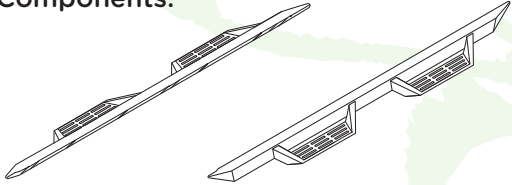

Components:



Passenger Side Step Bar Qty 1

Driver Side Step Bar Qty 1

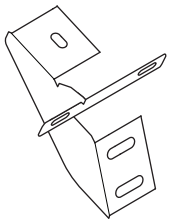

Front Mounting Brackets (Medium) Qty 2

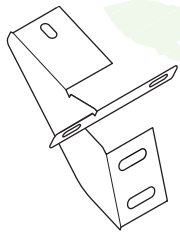

Center Mounting Brackets (Long) Qty 2

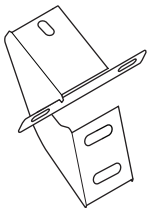

Rear Mounting Brackets (Short) Qty 2

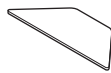

Front Armor Plates Qty 4

Hardware:



M10 Flat Washers Qty 6



M6 Lock Washers Qty 12



M10 Lock Washers Qty 6



M6 x 25MM Button Head Bolts Qty 12

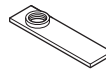

M10 Nut Plates Qty 6

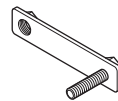

RTSPN175 Bolt/Nut Plates Qty 6

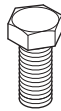

M10 x 30MM Hex Head Bolts Qty 6



M8 Plastic Push Nuts Qty 6



M8 x 25MM Hex Head Bolts Qty 12



M8 Flat Washers Qty 18



M8 Lock Washers Qty 18



M8 Hex Head Nuts Qty 6



M6 Hex Head Nuts Qty 12



M6 Flat Washers Qty 24

Tools Required:

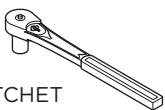

RATCHET



TORQUE WRENCH



13MM SOCKET



10MM SOCKET



4MM HEX BIT

Torque Specifications:

For Rocker Panel Mount Installations
M8 through M12 bolts and nuts are set to 15-20 ft lbs.

Note: When installing the brackets and bars, all hardware must be left loose until all the items are attached.

Remove all contents from the package and check steps for any damage. Also, verify that all components and hardware listed above are included before you begin installation.

Read installation manual and installation drawing completely. Understand all brackets and bolts before installation.

1. On passenger side of jeep, align Front, Center and Rear Brackets as shown.

2. Starting on the passenger side front, locate the bracket mounting location on the underside of the Jeep body.

If the Jeep body is not pre-threaded

3. If the Jeep body is not Pre-Threaded then you will install the brackets to the body using the Non-Threaded Hardware Pack. Locate the square opening in the floor body channel. Insert one (1) M10 Nut Plate into the opening.

Next, fasten the bracket to the M10 Nut Plate using one (1) M10 x 30MM Hex Head Bolt, one (1) M10 Lock Washer and one (1) M10 Flat Washer.

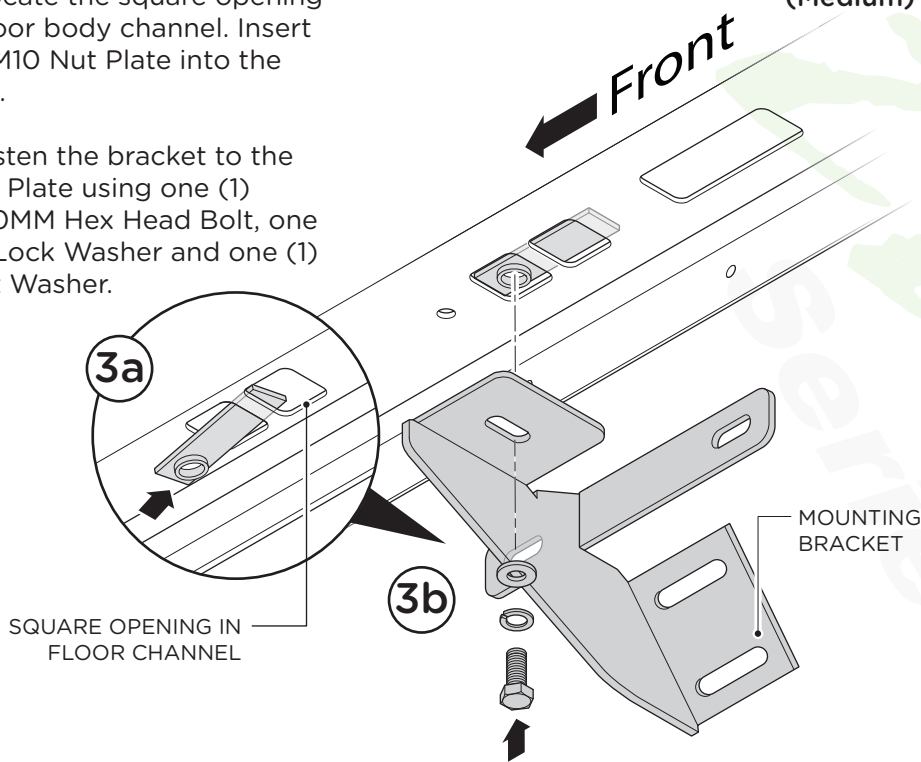
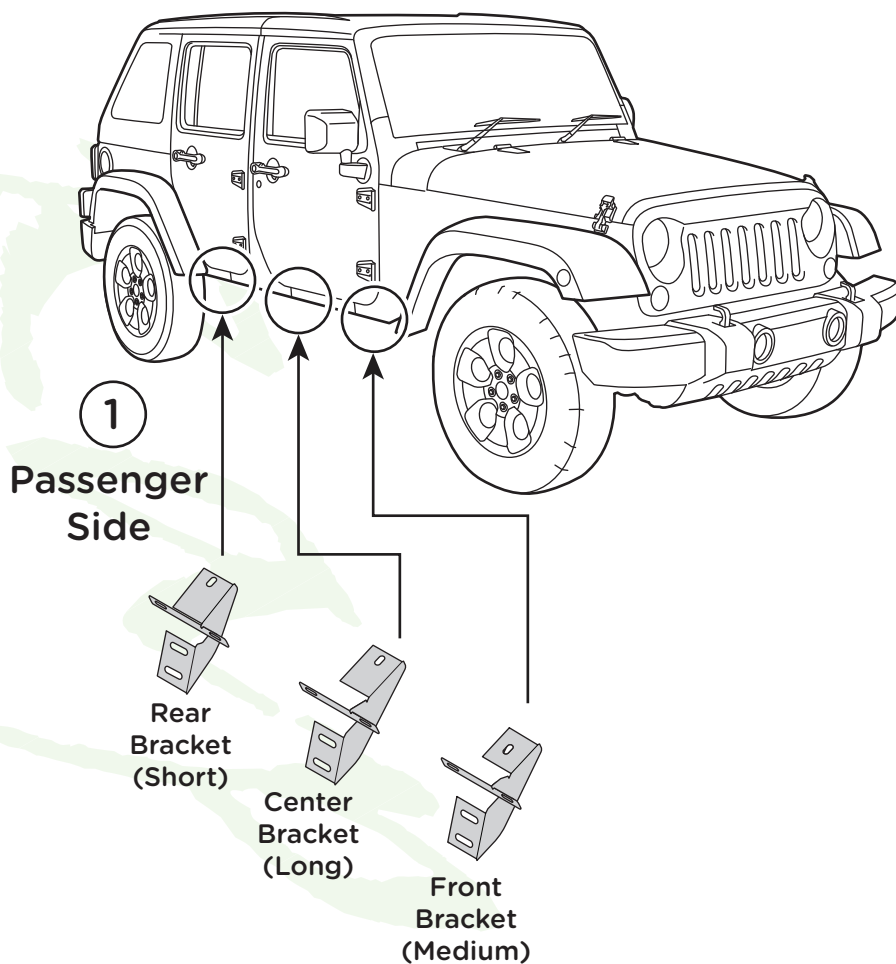



Non-Threaded Hardware Pack

- M10
- 6x
- 6x
- 6x
- 6x

If the Jeep body is pre-threaded

4. If the Jeep body is Pre-Threaded then you will install the brackets to the body using the Pre-Threaded Hardware Pack. Start by fastening the bracket to the pre-threaded hole using one (1) M8 x 25MM Hex Head Bolt, one (1) M8 Lock Washer and one (1) M8 Flat Washer.

Pre-Threaded Hardware Pack



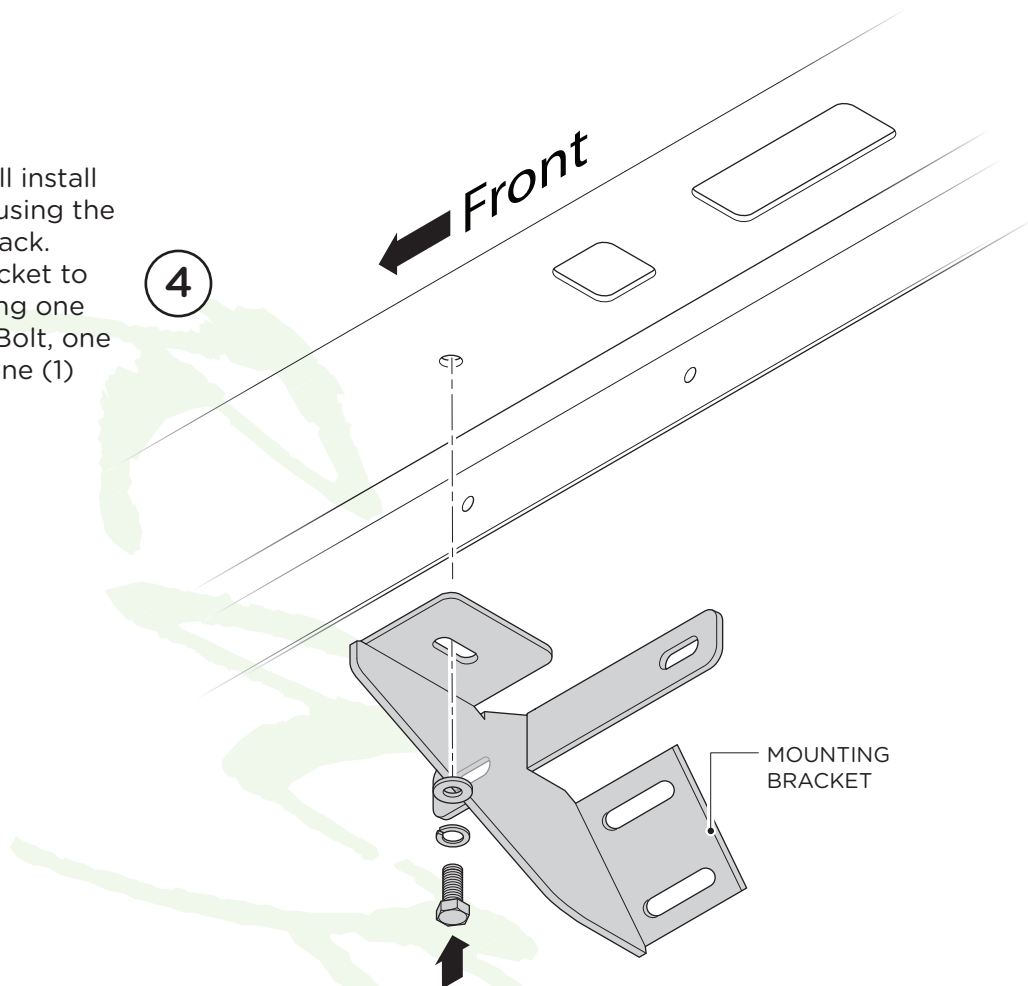

- M8
- 6x 
- 6x 
- 6x 



5. For both the Non-Threaded scenario and the Pre-Threaded scenario, attach the bracket to the pinch weld using two (2) M6 x 25MM Button Head Bolts, two (2) M6 Lock Washers, four (4) M6 Flat Washers and two (2) M6 Hex Head Nuts.

Repeat this procedure for the remaining brackets.

M6

- 12x 
- 12x 
- 24x 
- 12x 

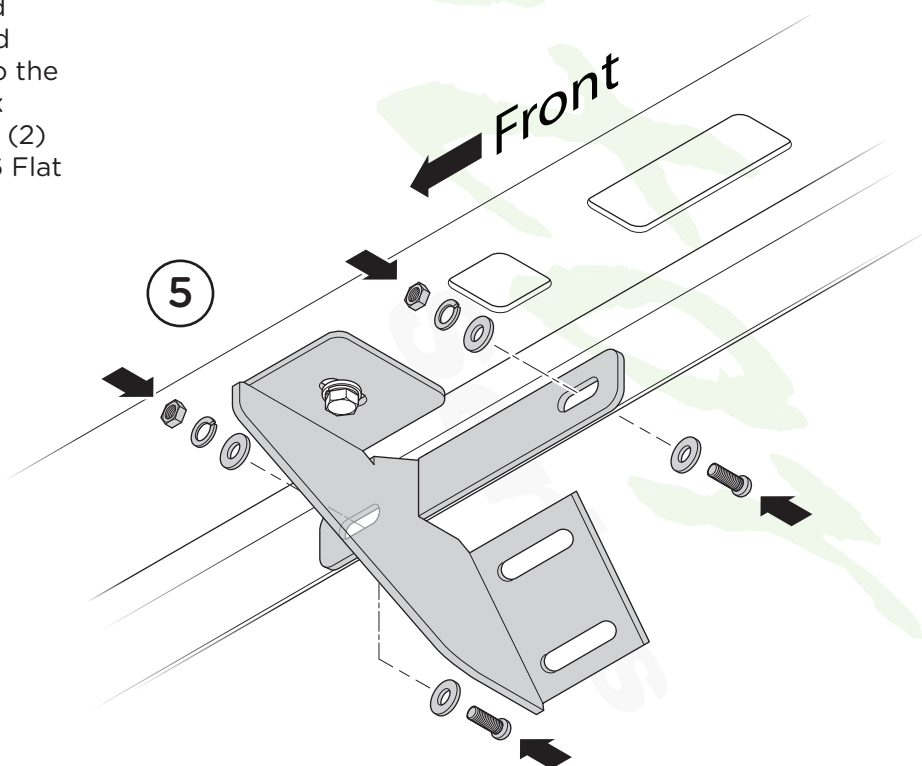

Installing the Step Bar

6. Line up mounting points on the step bar with the mounting holes in each bracket.

Fasten the step bar to each bracket using one (1) RTSPN175 Bolt/Nut Plate, one (1) Plastic Push Nut, one (1) M8 Hex Head Nut, two (2) M8 Lock Washers, two (2) M8 Flat Washers and one (1) M8 x 25MM Hex Head Bolt.

Adjust the bars front/back and up/down to desired placement. Once you have the step positioned, tighten until the split lock washer is flat between the bolt head and flat washer. Do not over tighten.

When all hardware is in place, everything must be tightened. See page 1 for torque specifications. Repeat these steps for opposite side installation.

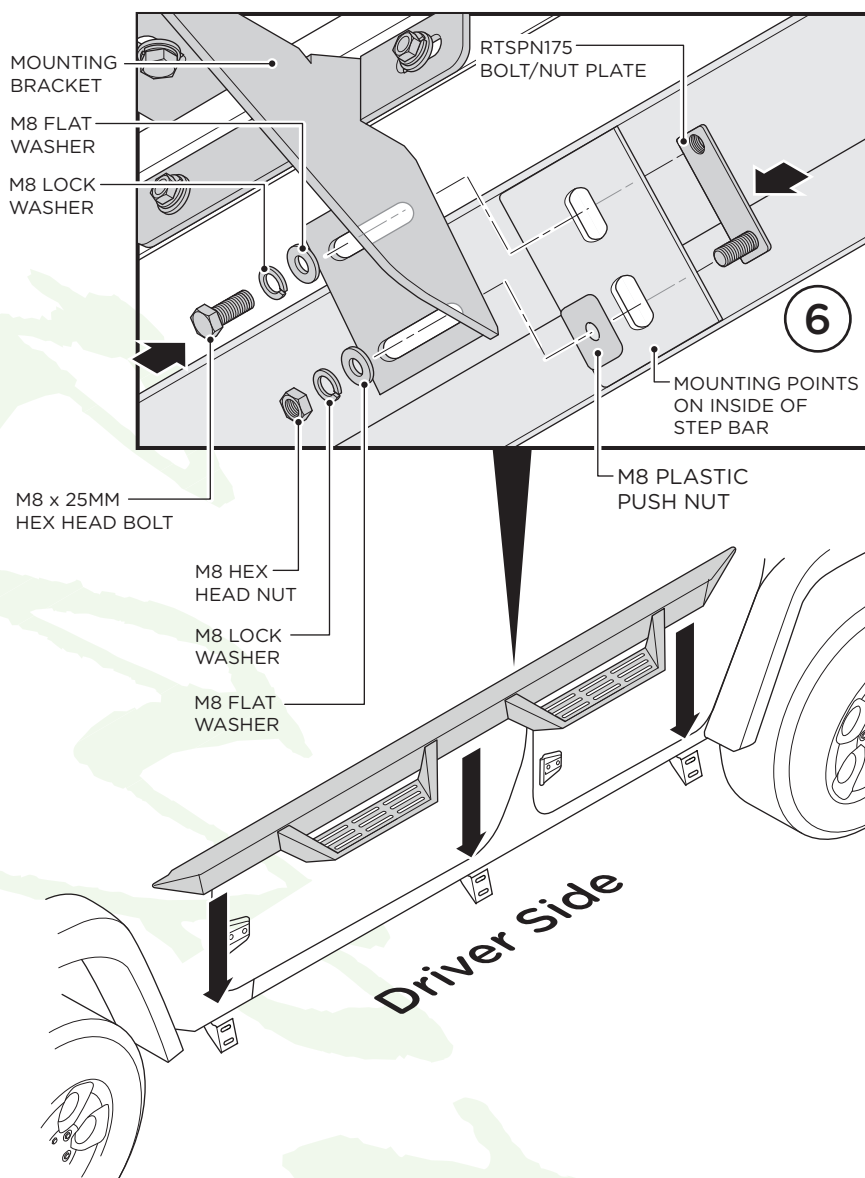

OPTIONAL:

If you wish to install the Front Armor Plates, begin by thoroughly cleaning the front side of the front step where the Front Armor Plate will attach.

1. Remove adhesive protection from the Front Armor Plate.

2. Carefully line up with the front side of the front step. Be careful not to let the side overhang as they could peel off over time.

Once lined up, firmly press the Front Armor Plate on the step to ensure complete adhesion.

Repeat these steps for opposite side.

