

RTS79TY/RTS83TY/RTW410TY

2005-2018 Toyota Tacoma RTS79TY/RTS83TY/RTW410TY Installation Instructions

Hardware Kit Includes Loose:

- (1) 18 – Hex head bolts (M8-1.25x20mm) Grade 8.8
- (2) 24 – Lock washers (M8) Grade 8.8
- (3) 24 – Flat washers (M8) Grade 8.8
- (4) 6 – Hex head nuts (M8-1.25) Grade 8.8
- (5) 6 – M8 Plastic Push Nuts

Components List:

- (1) 2 – RT Steps (Driver & Passenger)
- (2) 2 – Front Mounting Brackets (RTSPN095)
- (3) 2 – Middle Mounting Brackets (RTSPN005)
- (4) 2 – Rear Mounting Brackets (Driv/Pass) (RTSPN027)
- (5) 6 – M8 RT Step T Bolt (RTSPN175)

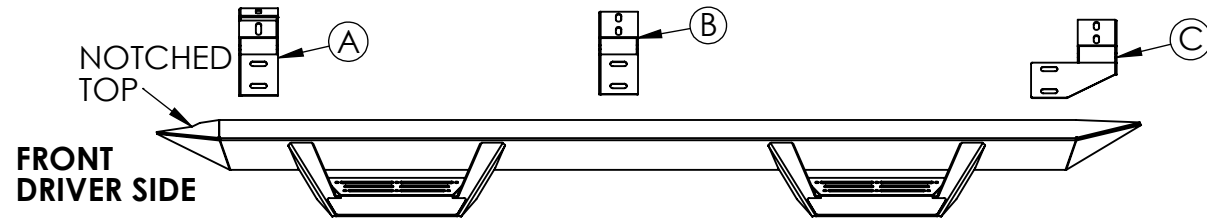

D - HARDWARE CONFIGURATION

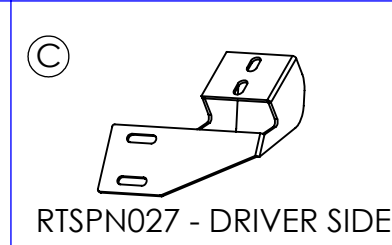
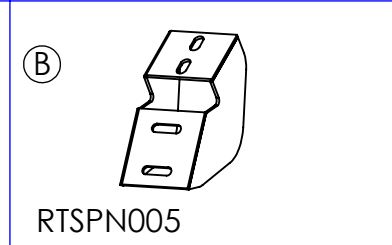
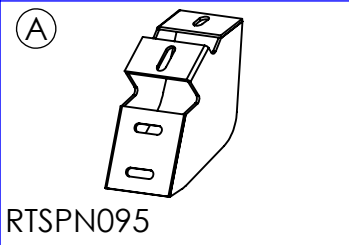
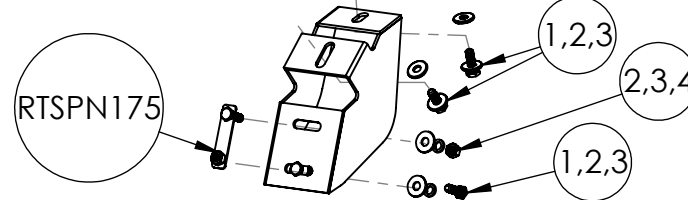

DISCLAIMER: USE ONLY COMPONENTS AND HARDWARE SUPPLIED BY ICI. NO SUBSTITUTIONS.

LOOSE FIT ALL COMPONENTS. DO NOT TIGHTEN UNTIL ALL COMPONENTS ARE INSTALLED AND ADJUSTED.



Step by Step Installation Instructions

- STEP 1:** Read and understand instructions completely before beginning installation.
- STEP 2:** Remove all old steps and hardware from truck.
- STEP 3:** Locate the driver's side step (center of front foot step is 20 5/8" to front of bar AND front of bar notch on top). Each step uses 3 mounting brackets. The bracket closest to the front of the vehicle is shown in figure A, the middle bracket is shown in figure B and rear bracket in figure C.
- STEP 4:** On the underside of the rocker panel there are 3 mounting locations down the length of the cab with 2 threaded holes per location. They may have plastic plugs covering them. Using provided M8x20mm hex head bolts, flat washers and lock washers, loose fit brackets to these locations. See figure D for hardware configuration.
- STEP 5:** Once all 3 brackets are loose fit to the truck, mount the RT Step to the brackets using provided RTSPN175 M8 T-bolts, 1 M8x20mm hex head bolt, 1 flat washer per bolt, lock washers and nuts. See figure D for hardware configuration.
- STEP 7:** Once RT Step is loose fit, tighten brackets to inside rocker. (**DO NOT USE IMPACT TOOLS**). Next, adjust bar up/down and front/back then tighten step to brackets. Repeat for passenger side.

RT STEPS & WHEEL TO WHEEL RT STEPS

04/27/18

ALL MAKES/MODELS OF RT STEPS & W2W RT STEPS (USING RTSPN175 T-BOLT)

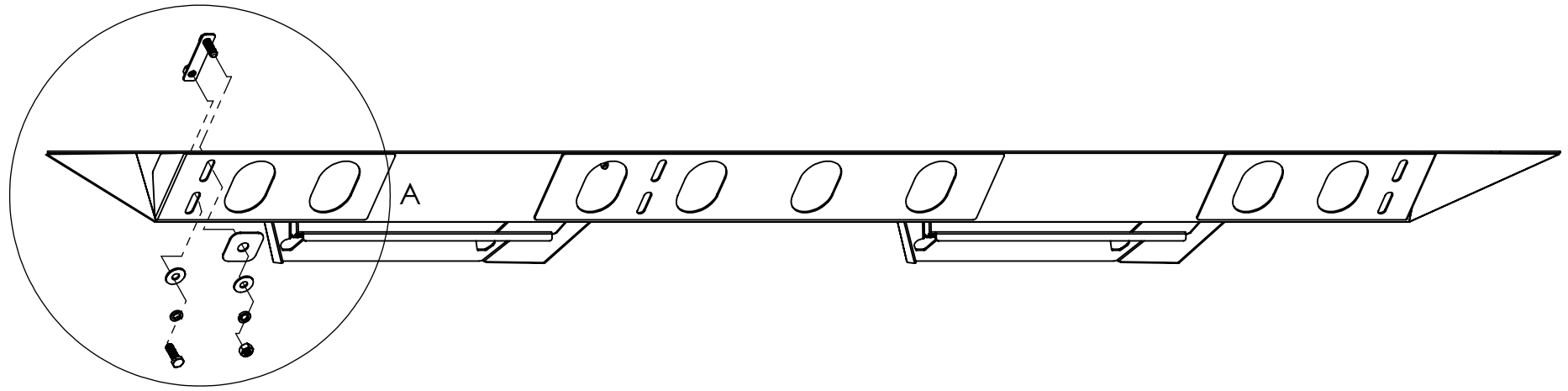

RTSPN175 - M8 RT STEP
MOUNTING T-BOLT

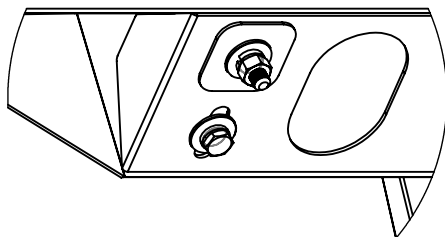
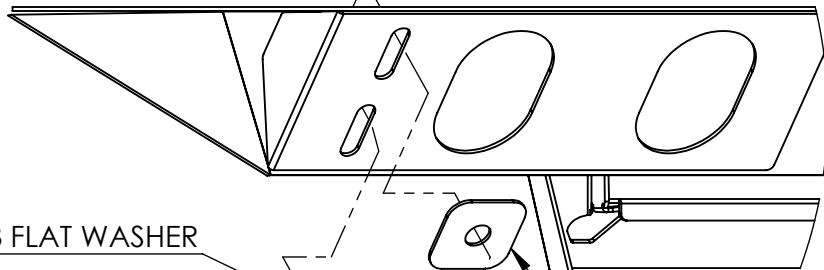

M8 FLAT WASHER

M8 LOCK WASHER

M8-1.25 x 20MM
HEX HEAD BOLT



M8 PLASTIC PUSH NUT

M8 FLAT WASHER

M8 LOCK WASHER

M8-1.25 HEX HEAD NUT